

# HEWLETT-PACKARD JOURNAL



FEBRUARY 1971



# HP/CAI

*This computer-assisted-instruction, or CAI, system makes impressive contributions to the state of the art of CAI. It's a combination of field-proven hardware, a standard computer language, and well tested curricula. The first curriculum is an elementary mathematics drill and practice program.*

**By William G. Ansley and Samuel D. Edwards**

THAT A NEW PRODUCT SHOULD contribute substantially to the state of the art has long been a philosophical tenet at Hewlett-Packard. It's somewhat paradoxical, therefore, that one of the major contributions of HP's computer-assisted-instruction system is that it is deliberately designed to have as few hardware and software innovations as possible.

At present the HP/CAI system consists of a mathematics drill and practice program running on the HP 2000B general-purpose BASIC-language time-shared computer system. The mathematical concepts covered are those normally encountered in grades one through six. 'Drill and practice' means that the concepts are presented by the teacher in the classroom and the CAI system gives the pupils practice in using the concepts.

The drill and practice program is written in BASIC and runs like any other program on the time-shared system. As it happens, the idea of a CAI program written in a high-level language and running on a general-purpose system is very unusual; before the HP system came along, the trend was toward special hardware and software. In fact, HP's use of *standard* teleprinters as terminals was also quite unusual at the time the system was introduced.

The advantages of standard general-purpose hardware and software are many. To name a few, reliability is generally much better, spare parts are readily available, and the system can be used for purposes other than CAI. Reliability is, of course, a concern of major importance to the school. The system simply must work and keep working with minimal maintenance.

Even more important than reliability, however, is the question of whether the curriculum is valid—do the stu-

dents learn? The HP/CAI mathematics curriculum is based on that originally developed by Dr. Patrick Suppes and his associates at the Institute for Mathematical Studies in the Social Sciences at Stanford University.\* There exists a great deal of field test data which clearly demonstrates that children receiving 5 to 10 minutes a day

\* A CAI Math Drill and Practice Program in Fundamentals of Arithmetic was developed under the direction of Dr. Patrick Suppes at Stanford University—Institute for Mathematical Studies in the Social Sciences, and was supported in part by the National Science Foundation, the U.S. Office of Education, and other agencies. The Hewlett-Packard instructional program is based upon this work. This reference does not constitute endorsement of the HP program by NSF, Stanford University, or other agencies.



## ***In this Issue:***

- HP/CAI, by William G. Ansley and Samuel D. Edwards . . . . .* **page 2**
- HP/CAI—In the Beginning . . . . .* **page 3**
- HP/CAI—The Future . . . . .* **page 9**
- Distortion in Complementary-Pair Class-B Amplifiers, by B. M. Oliver . . . . .* **page 11**



of CAI drill based on the Stanford curriculum show substantially better scores on standardized math tests than control groups not receiving the computer-assisted instruction.

Although based on this well validated curriculum, the HP curriculum has some extensions and is implemented quite differently. Students' placement in the curriculum and their progression through it have been made more flexible and individualized. Reports for teachers' use have been simplified. Problems are *generated* by the program, rather than *stored* as they are in other systems; this technique reduces the amount of data storage required to one-fiftieth of what it originally was and makes it possible to implement the Stanford curriculum on a small low-cost computer system that smaller school districts can afford.

#### Structure of the Curriculum

Mathematical concepts covered by the HP/CAI program are:

- Counting
- Horizontal and Vertical Addition
- Horizontal and Vertical Subtraction
- Units of Measure
- Horizontal and Vertical Multiplication
- Simple and Long Division
- Fractions
- Decimals
- Commutative, Associative, and Distributive Laws
- Negative Numbers

The structure of the curriculum is designed to achieve several objectives:

- to allow individualized student placement
- to provide material that is automatically adjusted to each student's achievement level so that every student can have successful learning experiences
- to allow an individualized rate of progression through the material to match each student's learning rate

## HP/CAI-In the Beginning

Hewlett-Packard has a history of involvement in education. Long a supplier of laboratory instruments to high schools, colleges, and universities, the company built its first computer in late 1966 and shortly thereafter produced its first educational computer product, the HP Educational BASIC System. A later system, the HP2000A Time-Shared BASIC System, has also proven useful in schools. Both systems allow many students to share the same computer and therefore minimize the per-student cost of computer equipment.

Neither of these systems, however, is a computer-assisted instruction (CAI) system. Both are intended primarily for computer-science education and scientific problem-solving. And while it may seem to be a logical extension of the company's previous efforts in education, the HP/CAI system didn't really come about that way. Instead, it grew out of the personal commitments of a few people. Had they not been associated with a company already heavily committed to the educational field the whole thing probably wouldn't have happened, of course. But they were. And it did.

In 1967 a technician named Kemp Miller joined the solid-state group in the Hewlett-Packard research laboratories. Soon Kemp had interested several other HP employees, including Bill Ansley, in an organization called Counterpart, which he had organized.\* As a Counterpart activity, Bill brought various data processing equipment to the Hoover Boys Club in East Palo Alto, California one evening per week. He observed the interest generated and the boys' enthusiasm.

In the early summer of 1968 Kemp called Bill and suggested he might be able to assist the local Ravenswood City School District in their CAI project in a voluntary, advisory capacity.

Bill met William Rybensky, the district's CAI project leader, and studied and observed the CAI activities for several months. By then he was hooked. He was convinced

that CAI was an exciting technique which combined the children's enthusiasm for equipment with sound psychological and pedagogical principles to offer a real solution to some serious educational problems.

Bill enlisted the unofficial support of Jim Rudolph and John Lazier of Hewlett-Packard Laboratories. Together they built a small, special-purpose computer terminal which seemed to offer a substantial, badly needed cost reduction for CAI.

It was at this time, in December 1968, that Bill decided to switch careers. He had been a computer user since he had first learned FORTRAN at Bell Telephone Laboratories in 1960, but hadn't previously considered leaving semiconductor device physics for a computer career.

Paul Stoff, a director of HP laboratories, offered Bill a chance to continue his investigation in CAI full time as a member of his section. During the spring of 1969, the original idea of a special terminal was shelved, and the concept of using standard terminals on an essentially standard HP time-sharing system was decided upon. Roy Clay, manager of software at HP's Cupertino division, was interested by the idea and offered Bill a transfer to Cupertino where the project has been carried on since June 1969. Sam Edwards joined the project in August 1969 and did most of the actual programming. A prototype system was installed at the Ravenswood City School District in November 1969, and the first production system was delivered in September of 1970.

Comments Bill Ansley: 'Many people helped in getting the CAI activity started. Everyone approached for help reacted with enthusiasm and interest. They saw an opportunity to make a personal contribution to a vital human and social need in education by using their particular technical skills.'

\* The August 1, 1970 issue of SATURDAY REVIEW has an article by Wallace Stegner which describes Counterpart and Kemp Miller's part in it. The title: 'East Palo Alto'.



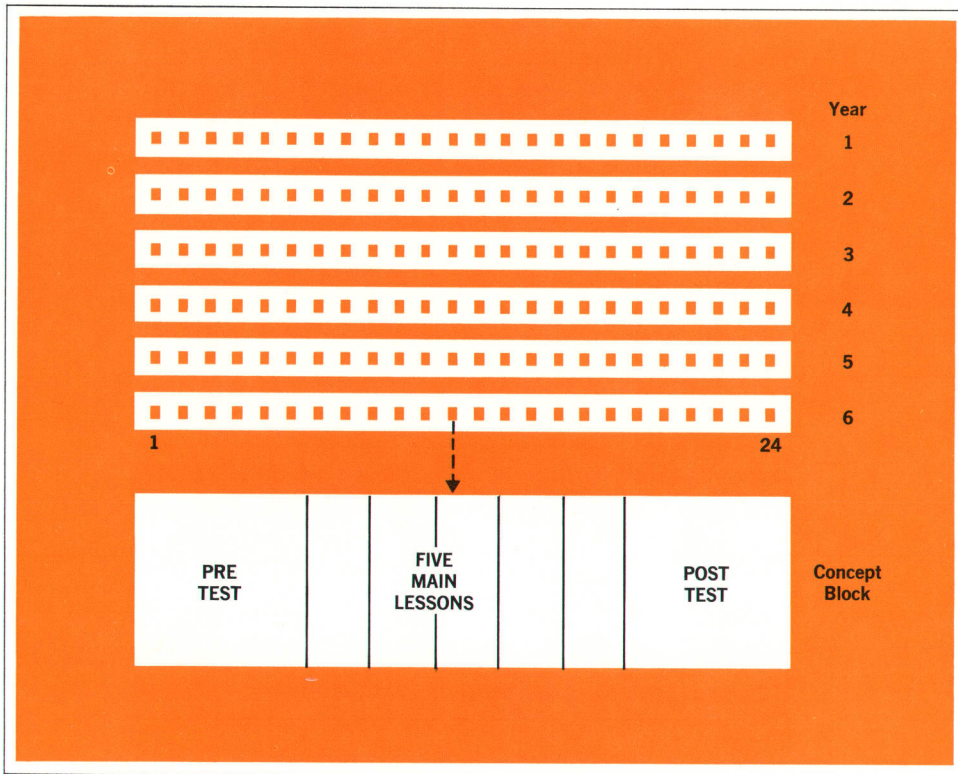

**Fig. 1.** The HP/CAI mathematics drill and practice curriculum is divided into six years. In each year are 24 concept blocks, each of which presents students with practice problems in a specific mathematical concept. A block consists of a pretest, five main lessons, and a post-test. Initially any student can be placed in any block by the teacher and thereafter he progresses sequentially from block to block.

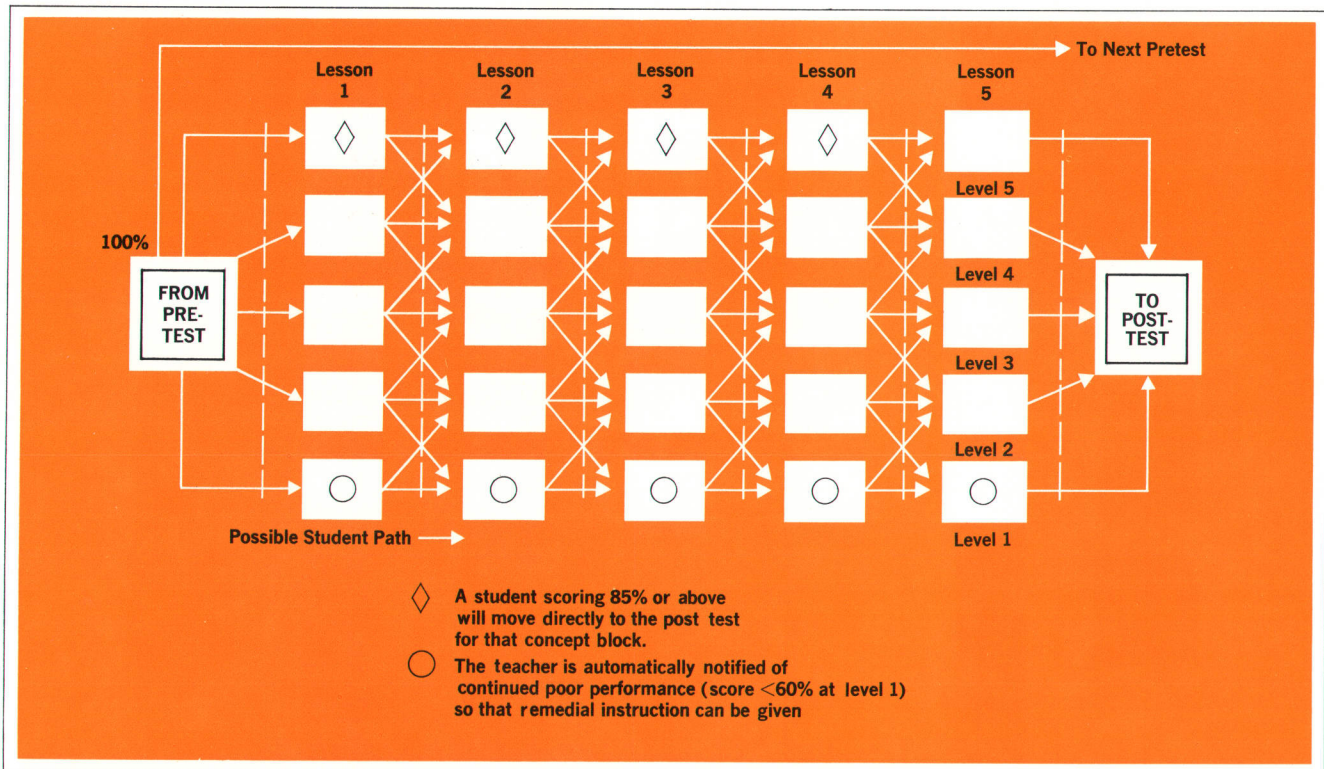

**Fig. 2.** Each main lesson is available at five levels of difficulty. Level 5 is the most difficult, level 1 the least difficult. A student moves up or down one difficulty level depending upon his score on the previous main lesson. If he gets 100% on the pretest he skips the entire block. Every student works independently and progresses at his own rate.



- to provide individualized review material to fit each student's needs
- to allow automatic skipping of material in which the student demonstrates competence.

The HP structure closely parallels the Stanford structure, but removes certain limitations of the original version. Skipping of material was not allowed in the Stanford system, and student placement and rates of progression were not completely independent as they are in the HP system.

The curriculum structure is illustrated in Figs. 1 and 2. Each year is divided into 24 blocks of material. Each block is one or a few specific types of math problems. Any student may initially be placed in any block chosen by the teacher. Thereafter the student progresses sequentially from block to block.

Each block consists of a pretest, five main lessons, and a post-test. Each main lesson is available at five levels of difficulty. Fig. 2 shows how a student may progress through a block.

The student first receives the pretest. This has problems from all of the five levels of difficulty available in the main lessons. Depending on his score on the pretest, the student takes one of six possible paths.

If he gets 100% on the pretest, he has demonstrated competence in the material contained in this block and he skips to the pretest in the next block. This avoids unnecessary drill.

If he gets a score of less than 100%, the student takes main lesson 1 at an appropriate difficulty level, depending on his pretest score. When he completes main lesson 1, his score on it determines whether his next main lesson will be at the same difficulty level, or one level higher, or one level lower. This branching continues after main lessons 1 through 4.

After main lesson 5, all students are given a post-test very similar to the pretest. The pretest and post-test combination provides a check of whether the students are showing improvement. The post-test scores for each student are also used to determine that student's review lessons.

What about students at level 1 (the easiest) and level 5 (the hardest)? How can they be moved down or up, as appropriate? In the first case, the teacher is notified on her daily report of any student who is performing poorly at level 1, so she may take remedial action. In the second situation, the student who achieves 85% or higher at level 5 is branched immediately to the post-test, skipping any further main lessons in that block. All main lessons contain essentially the same material, so if a student mas-

```

SEPTEMBER 16, 1970

WHAT IS YOUR ID NUMBER AND FIRST NAME?1100 TRACY
IS YOUR LAST NAME GEM?YES

HELLO TRACY. WE HOPE YOU ENJOY TODAY'S PROBLEMS.
R 3012
***** HERE WE GO !!!!! *****

17 - 0 = 17
10 + 1 = 11
7 + 3 = 10
11 - 9 = 3
WRONG, TRY AGAIN
11 - 9 = 2
15 + 2 = 17
2 + 8 = 9
WRONG, TRY AGAIN
2 + 8 = 10
16 - 8 = 8

LESSON OVER. YOU ANSWERED 5 OUT OF 7 QUESTIONS CORRECTLY.
GOODBYE, TRACY. PLEASE TEAR OFF ON THE DOTTED LINE:

```

Fig. 3. Typical HP/CAI lesson dealing with horizontal addition and subtraction. Student responses are in white. Since the system generates problems with random numbers, no two students ever get exactly the same lesson.

```

DAILY REPORT          HILLSDALE SCHOOL      SEPTEMBER 24, 1970
MISS JORDAN          FOURTH GRADE

JOHN ADAMS IS BELOW 60% AT LEVEL ONE IN BLOCK 3, YEAR 6.
TRACY GEM HAS SKIPPED 2 CONSECUTIVE BLOCKS
TO BLOCK 16, YEAR 5.
GEORGE MORGAN WAS ABSENT TODAY.
SALLY O'TOOL SIGNED IN THREE TIMES TODAY.
MARY YANCY WILL MEET A NEW CONCEPT IN BLOCK 16, YEAR 3.

```

Fig. 4. Daily report to teacher is a concise summary of only the unusual cases in a class.



CLASS REPORT			HILLSDALE SCHOOL			SEPTEMBER 24, 1970		
MISS JORDAN			FOURTH GRADE					
CURRENT MAIN LESSON			CURRENT REVIEW LESSON			NAME		
YR	BL	LEVEL BC	YR	BL	LEVEL			
3	3	TEST 2				ADAMS, JOHN		
3	8	5 7				GEM, TRACY		
3	10	TEST 9	3	4	4	MORGAN, GEORGE		
3	6	5 5	3	1	1	O'TOOL, SALLY		
3	8	TEST 7				YANCY, MARY		

(YR=YEAR BL=BLOCK BC=NUMBER OF BLOCKS COMPLETED)

Fig. 5. Weekly class report shows positions and rates of progress for all students in the class. An individual pupil report is available at the teacher's request.

ters one main lesson at the highest level of difficulty he has mastered that concept block.

Review lessons with essentially the same features are automatically intermixed with main lessons when they are needed by a student. The CAI system examines each student's post-test scores for blocks already completed, and schedules reviews. Blocks having the lowest post-test scores are reviewed first. Blocks with post-test scores over 85% are not reviewed. Skipping of material is not allowed in review lessons.

After completing a group of review lessons the student is again given a post-test, and the new post-test score replaces the former post-test score for that block in that student's file. Checks are built in to prevent repetitive review in any one block and to omit reviews on blocks where post-test scores are 85% or higher.

### Sample Lesson

Fig. 3 shows a sample lesson as it appears on the teleprinter. The student immediately learns whether his answer is right or wrong. If wrong, he is given another chance to determine the correct answer, but for internal scoring purposes only initially correct answers are considered right. Although not shown in this example, the student is told the correct answer after a second mistake on any problem and is asked to enter that correct answer for reinforcement.

Each student works independently, and all the student's work takes place privately without risking the ridicule of classmates or the possible displeasure of the

teacher. Also, the student is assured of having successful experiences because the difficulty level of his problems is adjusted automatically. These qualities are especially important for students who have had past histories of failures in school.

### Reports

Three reports inform the teacher of student progress and assist her in her classroom work.

The daily report gives the teacher a concise list of only the unusual cases in her class, and presents this in sentence form rather than cryptic tables. The sample report in Fig. 4 shows some of the situations that are reported including a 'new concept' coming up for Mary Yancy. This alerts the teacher that Mary will be meeting a particular concept for the first time in the course and may require some assistance if it has not already been discussed in class. Thus the reports help the teacher deal in the classroom with the spreads in achievement levels which the CAI system is treating in drill and practice.

Fig. 5 shows a sample class report which is typically furnished weekly to teachers. This shows the positions and rates of progress for all students in the class.

An individual pupil report is also available at the teacher's request. This gives the post-test scores and other data on all blocks completed by that student.

Another report, the curriculum report, gives the number of students in the school who have completed each block to date, along with the means and standard deviations of the pretest scores and post-test scores, and the pre-to-post-test differences. This information is necessary for continuing improvement of the curriculum.

Considerable effort went into making these reports concise, readable, and available on-line, at any terminal, whenever and wherever requested. By contrast, previous systems' reports to school personnel were voluminous tables with cryptic headings. For efficiency, because of their number and size, they were produced on a line printer at a central location and distributed to the teachers and staff, who usually glanced at them with dismay and then quickly deposited them in the circular file. On the other hand, the HP reports have proved to be well suited to the schools' interests and needs, and have played an important role in the acceptance and use of the system.

### HP/CAI Hardware

The HP/CAI hardware consists of the HP 2000B Time-Shared Computer System, shown in Fig. 6, along with a maximum of 32 teleprinters, which are the student





**Fig. 6.** The HP/CAI program runs on the HP 2000B Time-Shared Computer System. The system handles 32 students at a time. The central processor, shown here, is small enough to be located right in the elementary school, so telephone charges are minimized.

terminals. The central processor consists of standard HP hardware which has proven its reliability. It is a general-purpose system rather than a system dedicated to CAI.

The capacity of the system fits the needs of most schools quite well. Class scheduling considerations indicate that about 16 or about 32 terminals should be available, to allow handling a half class or a full class at one time. The average elementary school with an enrollment of 400 to 500 can get along with 16 terminals for one CAI curriculum. Larger schools would require 32 terminals. The usual rule of thumb is 30 to 40 students per day per terminal.

In a typical installation, the central processor and 32 terminals might be located in one school, or the processor and 16 terminals might be in one school and the other 16 terminals in a nearby school. This means communication costs are either zero or fairly low.

The student terminals are Model 33 Teletypes®. The

keyboards are standard with the sole exception that the ampersand (&) has been replaced by an underline. This modification is accomplished by changing the small print wheel on the Teletype, a three-minute job.

HP's use of standard terminals ran counter to a trend toward putting special 'CAI' features on the students' keyboards. These features were generally of little value, and to get them one had to accept many disadvantages, such as:

- lack of several common punctuation marks, a real drawback to language programs
- special characters which were so small that they were unreadable
- the need for relearning keyboards when going from CAI terminals to standard units for problem-solving or vice versa
- problems in the availability of servicing and parts

® Registered trademark, Teletype Corporation.



- inability to use programs developed on standard systems without reprogramming
- inability to use newer terminals such as Teletype-compatible CRT's as they become available.

#### HP/CAI Software

The system software is the same extended BASIC language used by commercial and scientific users. When the 2000B system was developed, several features were added to BASIC primarily for CAI.

The ENTER statement was added to allow timed student entries and certain other features. With this statement the teacher can specify a maximum number of seconds (up to 255) for a student to answer each problem. If the student doesn't enter an answer within the specified time the system proceeds with the lesson. Different times can be specified for each student.

The TIM (time) function is included so the system can read the real-time clock to determine when a student's session at a terminal is completed.

Three other features added for CAI also have use in other fields. The CHAIN statement allows a program to call a following program automatically. This allows, in ef-

fect, infinite program size. The COM statement provides an area of common storage between chained programs so data can be transferred quickly between programs. The CSAVE command allows programs to be saved in semi-compiled form; this eliminates about 90% of the compilation time when a new program is brought in with a CHAIN statement.

All the CAI programs are written in BASIC. BASIC has many operational advantages over either assembly language or special purpose 'author languages'. Among these advantages are:

- ease of programming. Program development is expedited because of the interactive nature of time-shared BASIC.
- improved reliability because of extensive debugging in previous applications
- the possibility of using the system for other things, such as solving problems or teaching students to program in BASIC. BASIC is a general-purpose language and it runs on a general-purpose system.
- the possibility of sharing CAI packages among users. BASIC is a more-or-less standard language which will run on many systems, whereas assembly language is



**Fig. 7.** *Students almost universally are enthusiastic about CAI, regardless of what system it is.*



specific to a given system. When changing from one manufacturer's BASIC to another's, some reprogramming may be necessary, but it will typically be very little.

### Generation Instead of Storage

In the HP/CAI system the Stanford curriculum is implemented quite differently from the original. In the original Stanford version the computer system stored every problem and its answer. This was an aid in gathering research data, but it took an enormous amount of storage.

In the HP system problems and answers are *generated* as needed, subject to the constraints specified for each lesson in the Stanford curriculum. As a result, the storage needed for the math program has been reduced by a factor of 50, making it feasible to run the program on a small, low-cost system.

What generation means can best be explained by an example. Suppose the lesson deals with horizontal addition problems with sums between 10 and 14. Instead of storing a large number of problems such as  $5 + 5 = 10$ ,  $5 + 9 = 14$ ,  $8 + 3 = 11$ , and so on, the HP system inserts random integers for A and C into the equation

$$A + B = C$$

subject to the constraint that C must be between 10 and 14. The system then computes B and presents the problem to the student as

$$A + B = \underline{\quad}$$

The BASIC programming required to do this is as follows:

```
C = INT(5 * RND(X) ) + 10
A = INT( (C + 1) * RND(X) )
B = C - A.
```

The first statement generates a number C between 10 and 14. RND(X) gives a random number between 0 and 0.999999, and the expression INT( ) takes the integer part of the quantity within the parentheses. The second statement generates a new integer A between zero and the sum C. The third statement simply subtracts A from C.

Although in this example the algorithm for generating the required problem is relatively simple, the algorithms for most lessons are considerably more complex. Many more requirements must be satisfied, such as limits on values of addends, carrying or borrowing in specific columns, and avoiding ambiguous problems in units of time (e.g.  $\underline{\quad}$  DAYS = 1 MONTH). Considerable doubt was expressed by several people in the CAI field as to whether it was possible to write suitable algorithms for

## HP/CAI-The Future

Additional CAI activities are now going on at HP in the areas of hardware, system software, applications programming, and support. Applications programming projects include:

- Implementation of an elementary English curriculum on HP 2000 systems. This program, covering material normally taught in grades four through six, is scheduled for release in early 1971.
- revision of the math program to make it even more effective and to make it available on both the 2000B and the 2000C
- development of a number of general CAI packages which will assist university-level people in developing their own materials
- studies of possible efforts in higher-level mathematics and in initial reading.

Hardware and system programming efforts are aimed at implementing present CAI programs on the 2000C system.

New support activities include recent establishment of an advisory council to assist in planning and in development of an educational users' group to assist in information exchange among the more than 250 educational institutions using HP computer systems.

some types of problems, but the HP/CAI math package has settled that question.

Generation rather than storage of problems provides other advantages, too. The lesson specifications are stored compactly in files, so it's easy to revise and update the curriculum by simply updating those brief specifications. There is no need of manually revising and editing a data base of 4.5 million characters. Generation also means that the lessons are essentially cheatproof, because no two students ever get exactly the same lesson.

### Trade-offs

When a different approach to a task is used, there are usually trade-offs involved. In the case of the math package, there were two primary trade-offs. On-line generation of problems is not very attractive for word problems, such as 'If I have two apples and four oranges, how many pieces of fruit do I have?' Although word problems could have been provided, either by storage or by a quasi-random selection among sentence elements, they were *not* included in the package. After careful study, it was decided that the long printing time for word problems, the common reading difficulties of students, and the need for more human interaction in teaching word problems made it unwise to include them.

The only other major change, compared with some older CAI systems, was the deletion of student response records. Some systems have recorded every student response on every part of every question for 'possible later analysis.' Since this information is primarily of interest



to research workers and not to the typical school system, the reduction in system cost more than justified eliminating these records.

### Gratifying Response

The prototype HP/CAI system has now been in use by approximately 500 students at Willow School in East Palo Alto, California for more than a year. So far, the response has been gratifying. Students have almost without exception been extremely enthusiastic about the system. HP cannot claim any special credit for this since CAI seems to be a very powerful motivating factor regardless of the details of the system. Teachers and administrators have also been very pleased with the system. Its reliability and the nature of the reports it produces have pleasantly surprised most of the staff involved. In the CAI field, the HP ideas of a higher-level language on a general-purpose system, standard terminals, use of generation techniques, small systems tailored to meet school needs, and others, seem to be gaining acceptance.

### Synergistic Development

Worthy of special mention are the procedures that were used in developing the HP/CAI package. The universal practice in CAI had been to have the effort segmented into curriculum, system analysis, programming, coding, and so on. Too often, this procedure led to communications problems between members of the team.

By contrast, the HP/CAI package was developed by a small number of people who were involved across the complete spectrum of the task. In particular, the opportunity for those doing programming in BASIC directly to observe students and teachers using the system, coupled with these programmers' deep involvement in the analysis of the curriculum for developing algorithms, resulted in a powerful synergistic effect. Difficulties that students experienced were directly observed and corrected, often within a few minutes by a programmer working on-line at the site.

### Acknowledgments

Of the many people who contributed to this project, we would like to mention just a few. Without the able assistance of Mr. Ronald Weaver, former principal of Willow School where the field test was conducted, and Mr. William Rybensky, CAI project director for the Ravenswood School District, we could never have finished the work. Dennis McEvoy and Ron Crandall, HP systems programmers, not only provided needed system features in an amazingly short time, but also offered general advice and guidance. Ed McCracken and Jim

Candlin were and still are responsible for many supporting activities vitally necessary to the system's development and delivery as a useful product. Dick Moley, Lee Johnson, and Waldy Haccou all helped guide us in getting the job done. Carol Berte, Steve Stoff, and Bill Green helped get the ball rolling as summer employees. Paul Stoff and Roy Clay helped us keep the faith. 

### William G. Ansley



Bill Ansley received his BS degree in engineering physics from the University of Toledo in 1954. He embarked on a career with Bell Telephone Laboratories, only to have it interrupted by a notice from his draft board. He was inducted into the army in September 1955 and was assigned to Aberdeen Proving Grounds as an engineer evaluating radar-controlled antiaircraft weapons. After his discharge, Bill did graduate work and served as

a teaching assistant in the physics department of the University of Illinois. In 1959 he resumed his career at Bell Labs, working in semiconductor device design. He joined the solid-state section of Hewlett-Packard Laboratories in 1965. The story of how he abandoned semiconductor device physics and became a senior systems analyst working on CAI is told on page 3.

Bill is a member of IEEE. He holds patents on a semiconductor pressure transducer and on an optical filter used with solid-state light sources.

### Samuel D. Edwards



Sam Edwards received his BS degree in mathematics from Stanford University in 1964. After a year of graduate work in mathematics, also at Stanford, he joined the Peace Corps and was sent to Malaysia, where he served three years as a mathematics instructor at the Victoria Institution and the University of Malaya, both in Kuala Lumpur. On his way home from Malaysia, Sam stopped off for three months in Nepal, where he realized a long-

time ambition by climbing to the base camp of Mt. Everest, 20,000 feet above sea level. In August 1969 he ended up at HP's Cupertino Division as the principal programmer for the HP/CAI mathematics program. Currently he is finishing the programming for a soon-to-be-released elementary English CAI program.

Sam will receive his MS degree in mathematics from Stanford as soon as he completes one more course. He speaks German and Malay as well as English. He likes backpacking, skiing, and scuba diving, and has a peculiar penchant for climbing volcanoes—he has eight to his credit so far.



# Distortion in Complementary-Pair Class-B Amplifiers

*In which the author develops, among other things, a new treatment of crossover distortion*

By B. M. Oliver

THERE ARE TWO PRINCIPAL TYPES OF DISTORTION in class-B amplifiers using complementary pairs of transistors. One is caused by  $\beta$  difference between the two transistors; the other, known as crossover distortion, is caused by differences in the slope of the transfer characteristic near the operating point as compared with the slope at high current levels. We shall consider both types using a general approach applicable to a wide variety of particular circuit configurations and shall study the effectiveness of negative feedback in suppressing the distortion. In all cases we assume a sinusoidal input and take as the measure of distortion the ratio of total harmonic power to fundamental power in the output.

## $\beta$ -Difference Distortion

Consider the circuit of Fig. 1, in which two transistors having different  $\beta$ 's are biased by an appropriate means and have their common emitter node connected to a load resistor,  $R_2$ . The source is assumed to have an internal resistance,  $R_1$ . There are, of course, little resistances like  $R_b$ , the base ohmic resistance, and  $R_e$ , the emitter resistance, but for the moment we shall consider these to be included in  $R_1$  and  $R_2$ . Since we shall be considering large

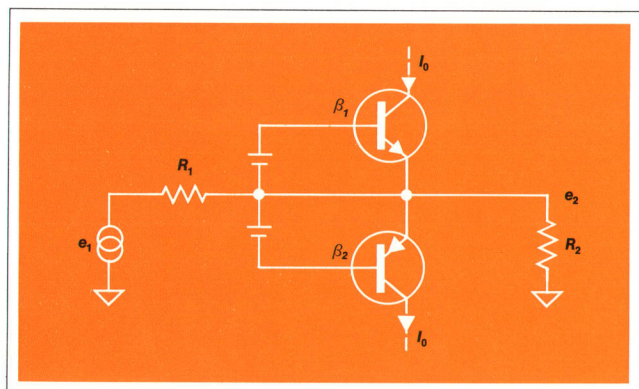

Fig. 1. Two transistors of different  $\beta$  feed common load.

signals here, we shall neglect the junction-law distortion and assume the junction resistance to be zero for forward bias and infinite for reverse bias.

For  $e_1$  positive, the transmission is given by

$$k_1 = \frac{e_2}{e_1} = \frac{R_2}{(1 - \alpha_1) R_1 + R_2} = \frac{\beta_1 R_2}{\alpha_1 R_1 + \beta_1 R_2} \quad (1a)$$

where  $\alpha_1$  is the  $\alpha$  of the upper transistor. Similarly for negative  $e_2$ ,

$$k_2 = \frac{e_2}{e_1} = \frac{R_2}{(1 - \alpha_2) R_1 + R_2} = \frac{\beta_2 R_2}{\alpha_2 R_1 + \beta_2 R_2} \quad (1b)$$

The ratio of these transmissions is

$$\frac{k_1}{k_2} = \frac{\beta_1}{\beta_2} \frac{\alpha_2 R_1 + \beta_2 R_2}{\alpha_1 R_1 + \beta_1 R_2} \quad (2)$$

If  $R_1$  is infinite (current source of magnitude  $\frac{e_1}{R_1}$ ) then

$$\frac{k_1}{k_2} = \frac{\alpha_2 \beta_1}{\alpha_1 \beta_2} \approx \frac{\beta_1}{\beta_2}$$

while if  $R_1$  is much less than  $\beta R_2$ , then  $k_1/k_2 \approx 1$ . The ratio of  $R_2/R_1$  determines the amount of local feedback or degeneration and affects the ratio of the transmission for positive signals to that for negative signals.  $\beta$ -difference distortion thus depends upon the circuit configuration and will in general be low if the pair is voltage driven and high if the pair is current driven. The point is that, for any configuration, one can always find the appropriate  $k_1$  and  $k_2$  and from these compute two normalized slopes

$$m_1 = \frac{k_1}{(k_1 + k_2)/2} \quad \text{and} \quad m_2 = \frac{k_2}{(k_1 + k_2)/2} \quad (3a)$$

which have the properties

$$\frac{m_1 + m_2}{2} = 1 \quad \text{and} \quad \frac{m_1}{m_2} = \frac{k_2}{k_1} \quad (3b)$$

We are now in a position to represent the actual amplifier, whatever its configuration, by a linear amplifier followed by a non-linear device having the transfer characteristic shown in Fig. 2, where  $w$  is the input amplitude and  $v$  the output amplitude. We neglect all curvature at the origin, present in actual devices, electing instead to



simplify the analysis and obtain a slightly pessimistic result.

In the feedback amplifier of Fig. 3, which incorporates our non-linear device, we have for positive signals

$$v^+ = \frac{m_1 \mu}{1 - m_1 \mu \beta} s^+ \quad (4)$$

and similarly, for negative signals:

$$v^- = \frac{m_2 \mu}{1 - m_2 \mu \beta} s^- \quad (5)$$

$\mu\beta$  is the loop gain if  $v = u$  (unity slope). This  $\beta$  is the traditional feedback ratio. Nothing to do with transistors!

If  $m$  were unity and we wished an output

$$y = a \sin \phi, \quad (6)$$

we would need an input

$$w = \frac{1 - \mu\beta}{\mu} a \sin \phi; \quad (7)$$

with this input and the actual transfer characteristic, the output will be

$$y = as_1 \sin \phi, \quad y \geq 0 \quad (8)$$

$$y = as_2 \sin \phi, \quad y \leq 0$$

where

$$s_i = \frac{1 - \mu\beta}{1 - m_i \mu \beta} m_i, \quad i = 1, 2. \quad (9)$$

$s_1$  and  $s_2$  are, of course, the transfer characteristic slopes as modified by the feedback. Both approach unity as  $\mu\beta \rightarrow \infty$  unless  $m_1$  or  $m_2$  is zero.

The amplitude of the fundamental component in the output is:

$$a_1 = \frac{\int_{-\pi}^{\pi} y \sin \phi \, d\phi}{\int_{-\pi}^{\pi} \sin^2 \phi \, d\phi} = a \frac{s_1 + s_2}{2}. \quad (10)$$

The mean square departure from the fundamental is

$$\overline{\delta a^2} = \frac{\int_{-\pi}^{\pi} (y - a_1 \sin \phi)^2 \, d\phi}{\int_{-\pi}^{\pi} d\phi} = \frac{a^2}{8} (s_1 - s_2)^2. \quad (11)$$

The distortion,  $d$ , is given by

$$d = \frac{\text{rms departure}}{\text{rms fundamental}} = \frac{\sqrt{\overline{\delta a^2}}}{a_1} = \frac{|s_1 - s_2|}{s_1 + s_2} \quad (12)$$

$$= \left| \frac{m_1 - m_2}{2} \right| \left| \frac{1}{1 - m_1 m_2 \mu \beta} \right|$$

The distortion is reduced by feedback but the effective loop gain is not  $\mu\beta$  but  $m_1 m_2 \mu \beta$ . Thus, if either  $m_1$  or  $m_2$

is zero, the feedback is useless. On the other hand, if  $m_1 = 1 + \Delta$  and  $m_2 = 1 - \Delta$  where  $\Delta \ll 1$ , then  $m_1 m_2 = 1 - \Delta^2 \approx 1$ , and we can consider the normal feedback as being effective. We note that, for the sharp-cornered transfer characteristic we have assumed, the  $\beta$ -difference distortion is independent of amplitude.

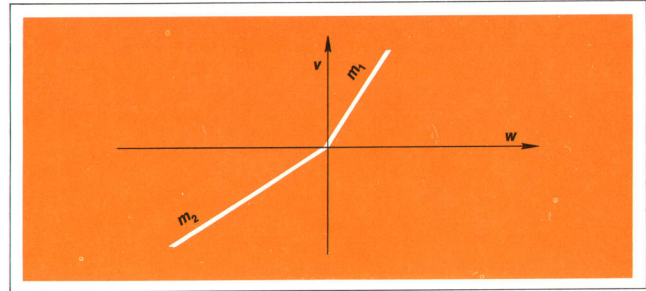

Fig. 2. Amplifier transfer characteristic, input  $w$  vs. output  $v$ .

### Crossover Distortion

Fig. 4 shows a typical emitter follower class-B output stage. The transistors are forward biased by a current  $I$  flowing through two diodes and a resistor.  $R_s$  is the total resistance of this diode string. We include a resistor  $R_s$  in the base lead of the upper transistor to keep the circuit symmetrical. Each emitter is coupled to the output through a resistor  $R_c$ .

We will first analyze this circuit exactly to see if there is an optimum value of  $R_c$  so far as crossover distortion is concerned. Assuming the transistors to be identical so that there is no  $\beta$ -difference distortion, all distortion will arise from the non-linearity of the emitter-base junction law. To find an optimum  $R_c$ , we need only minimize the variation in output resistance with signal current. Accordingly, we ground the input to the stage and apply a voltage to the output as shown in Fig. 5.

Let  $R$  be one-half the ohmic resistance around the emitter base-bias loop, referred to the emitter:

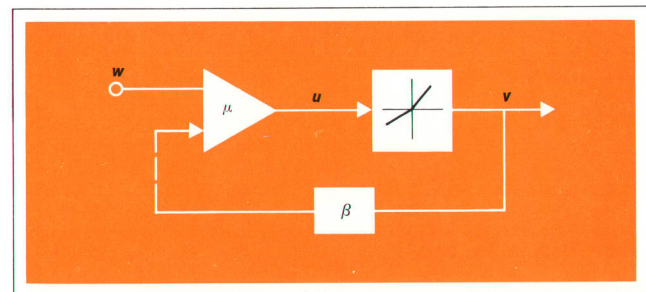

Fig. 3. Feedback amplifier incorporating nonlinear element.

$$R = (1 - \alpha)(R_s + R_b) + R_e + R_c. \quad (13)$$



If  $I_o$  is the operating current and  $i_1$  and  $i_2$  are the signal currents produced by the voltage  $e$ , we then have

$$i = i_2 - i_1 \quad (14)$$

and

$$\frac{kT}{q} \ln \left( 1 + \frac{I_o + i_1}{I_s} \right) + R(I_o + i_1) = V_o - e \quad (15)$$

$$\frac{kT}{q} \ln \left( 1 + \frac{I_o + i_2}{I_s} \right) + R(I_o + i_2) = V_o + e. \quad (16)$$

$I_s$  is the saturation current of each transistor,  $i$  and  $e$  the output current and voltage. When  $i = 0$ ,  $i_1 = i_2 = 0$  and  $e = 0$ , so

$$V_o = \frac{kT}{q} \ln \left( 1 + \frac{I_o}{I_s} \right) + RI_o. \quad (17)$$

Substitution of this expression into (15) and (16) gives, after multiplication throughout by  $\frac{kT}{q}$  and neglecting  $I_s$  in the result:

$$\ln \left( \frac{i_1}{I_o} \right) + g_o R \left( \frac{i_1}{I_o} \right) = -\frac{qe}{kT} \quad (18)$$

$$\ln \left( \frac{i_2}{I_o} \right) + g_o R \left( \frac{i_2}{I_o} \right) = \frac{qe}{kT} \quad (19)$$

where  $g_o = \frac{qI_o}{kT}$  and is the emitter conductance at the operating point.

If we assume a value for  $\frac{i_2}{I_o}$ , we can easily compute the corresponding value of  $\frac{qe}{kT}$ . But then to find  $\frac{i_1}{I_o}$  from (18) involves the solution of a transcendental equation. No way being known to rewrite (18) explicitly in  $\frac{i_1}{I_o}$ , the 9100A Calculator was programmed to find this quantity by successive approximations.

Having found  $\frac{i_1}{I_o}$ , it is then a simple matter to compute the output resistance  $R_o$ , or rather the normalized quantity  $g_o R_o$ , which consists of the two normalized resistances

$$g_o R_1 = g_o R + \frac{1}{1 + i_1/I_o} \quad (20)$$

and

$$g_o R_2 = g_o R + 1 + \frac{1}{i_2/I_o} \quad (21)$$

in parallel.

As  $\frac{i_2}{I_o} \rightarrow \infty$ ,  $\frac{i_1}{I_o} \rightarrow -1$ . Thus  $g_o R_o \rightarrow g_o R_2 \rightarrow g_o R$ . The difference,  $\Delta g_o R_o$ , between  $g_o R_o$  and its limiting value for large signal currents is therefore

$$\Delta g_o R_o = g_o (R_o - R). \quad (22)$$

The 9100A was used not only to solve for  $\frac{i_1}{I_o}$ , but to compute and plot the 9125A plotter  $\Delta g_o R_o$  as a function

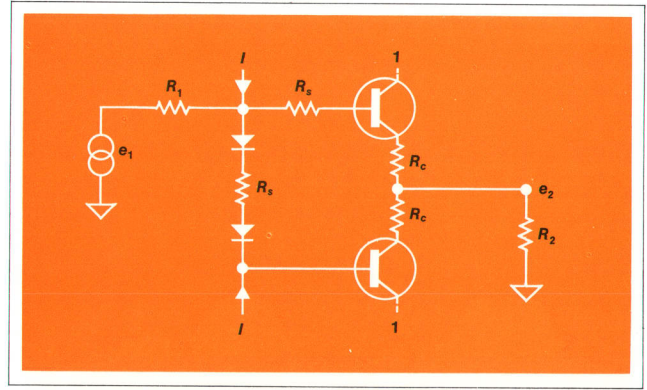

Fig. 4. Typical emitter follower Class-B stage.

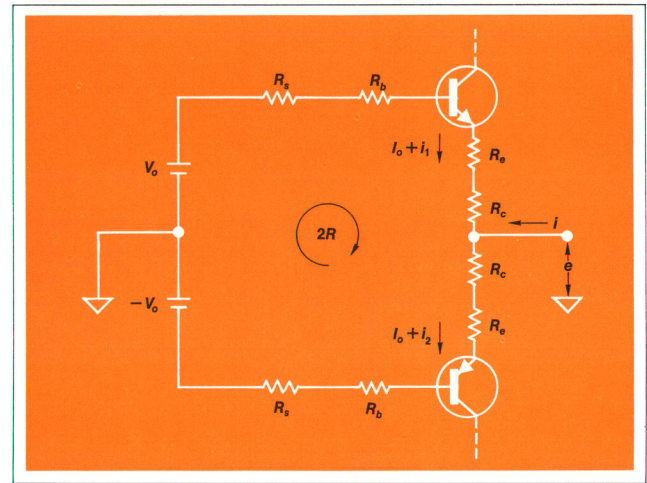

Fig. 5. To find optimum  $R_c$  input is grounded, voltage applied to output.

of

$$\frac{i}{I_o} = \frac{i_2}{I_o} - \frac{i_1}{I_o}. \quad (23)$$

The results are shown in Fig. 6.

We see that for  $g_o R_o = 0$ , the resistance falls with increasing signal currents, while for  $g_o R > 1$ , the resistance rises. With  $g_o R = \frac{1}{2}$ , the resistance falls monotonically as with  $g_o R = 0$ , but by only half as much. With  $g_o R = 1$ , the initial and final values of  $g_o R_o$  are the same but there is a bump in between at  $\frac{i}{I_o} \approx 4$ . Thus a value of  $R$  somewhere between  $\frac{1}{2g_o}$  and  $\frac{1}{g_o}$  is optimum.

However, the drop across this resistance produced by the operating current is only  $\frac{I_o}{2g_o} = \frac{1}{2} \frac{kT}{q}$  to  $\frac{I_o}{g_o} = \frac{kT}{q}$  or from 13 to 26 millivolts. Over the temperature ranges from  $0^\circ\text{C}$  to  $100^\circ\text{C}$ , the junction drop of a silicon transistor will change typically by 250 millivolts. Thus, unless the biasing diodes (see Fig. 4) track this change within a few percent,  $I_o$  will be very unstable. If the



biasing diode were integrated on the same chip with the transistor, accurate enough tracking might be achieved, in which case these results would be of practical interest.

At present the most practical solution to the temperature stability problem appears to be to make  $R_c$  many times larger than  $\frac{1}{g_o}$  and to rely on negative feedback to reduce the resulting distortion.

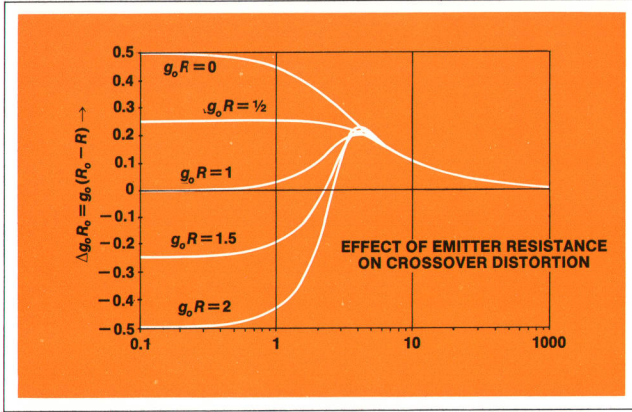

Fig. 6. Effect of emitter resistance on crossover distortion.

To avoid wasting signal power in  $R_c$ , these resistors may be shunted by diodes as shown in Fig. 7. If the operating current,  $I_o$ , produces a voltage drop in  $R_c$  greater than half the diode drop required to conduct currents on the order of  $I_o$ , then the diode on either side conducts and shunts out its  $R_c$  before the opposite transistor cuts off. As a result, the output resistance never rises as in the curves on Fig. 6 for  $g_o R > 1$ . Rather, neglecting the forward resistance of the diode, it drops by an amount

$$\frac{R_c - R_e - (1 - \alpha)(R_b + R_s)}{2}$$

at large signal currents, instead of rising by an amount

$$\frac{R_c + R_e + (1 - \alpha)(R_b + R_s)}{2}$$

Contrary to what one might expect, these power saving diodes do not increase distortion; they may actually reduce it slightly.

When the diode is open, the transmission of the stage, which we will call  $m\mu_2$ , is

$$m\mu_2 = \frac{e_2}{e_1} \Big|_{open} = \frac{R_2}{(1 - \alpha) + \left(R_1 + \frac{R_s + R_b}{2}\right) + \frac{R_e + R_c}{2} + R_2} \quad (24)$$

With the diode closed and the opposite transistor not yet open, the resistance of the path through the diode  $(1 - \alpha)(R_s + R_b) + R_e$ , is paralleled by the resistance of the path through the other transistor  $(1 - \alpha)(R_s + R_b) + R_e + R_c$ . Since the latter is ordinarily much larger, we will neglect this intermediate condition and assume the opposite transistor is always open when a diode is closed. The transmission is then

$$\mu_2 = \frac{de_2}{de_1} \Big|_{closed} = \frac{R_2}{(1 - \alpha)(R_1 + R_s + R_b) + R_e + R_2} \quad (25)$$

In all these expressions, we have neglected the diode transistor junction resistances. Dividing (24) by (25), we find

$$m = \frac{(1 - \alpha)(R_1 + R_s + R_b) + R_e + R_2}{(1 - \alpha)\left(R_1 + \frac{R_s + R_b}{2}\right) + \frac{R_e + R_c}{2} + R_2} \quad (26)$$

One diode or the other closes when the signal voltage at the emitters has the absolute value

$$e_o = \left(1 + \frac{2R_2}{R_c}\right) (V_d - I_o R_c) \quad (27)$$

For higher voltages, the conducting emitter and the output voltage differ by  $V_d$ , the diode drop.

Thus we can represent the entire non-linear stage by a linear amplifier of gain  $\mu_2$ , followed by a non-linear transfer characteristic of slope  $m$  up to the breakpoint and slope 1 thereafter. Further, if we agree to normalize all voltages by dividing by  $e_o$ , this breakpoint will have the abscissa 1, as shown in Fig. 8.

In Fig. 9, we show this equivalent stage as part of a feedback amplifier whose loop gain (above the breakpoint) is  $\mu\beta$ . In Figs. 8 and 9

$$w = \frac{e_{in}}{e_o} \quad (28)$$

$$x = \frac{\mu_2 e_1}{e_o} \quad (29)$$

$$y = \frac{e_2}{e_o} \quad (30)$$

A similar normalization is possible for other circuit configurations, so what follows is generally applicable.

Suppose we wish an output

$$y = a \sin \phi \quad (31)$$

If the transfer characteristic had unity slope throughout, this would require an input

$$w = \frac{1 - \mu\beta}{\mu} a \sin \phi \quad (32)$$

With the actual characteristic, the output up to the



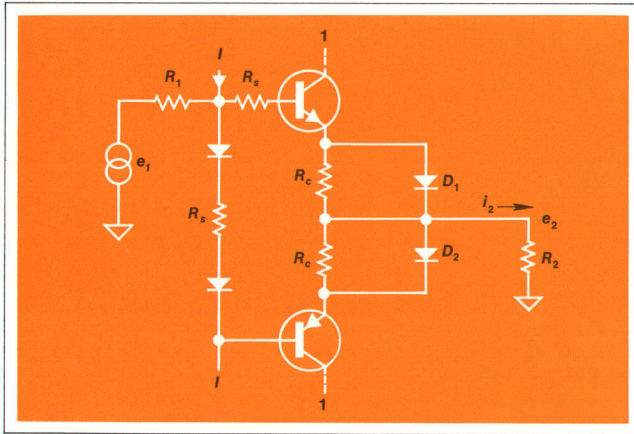

Fig. 7. Diodes shunt  $R_c$  to avoid wasting power in resistors.

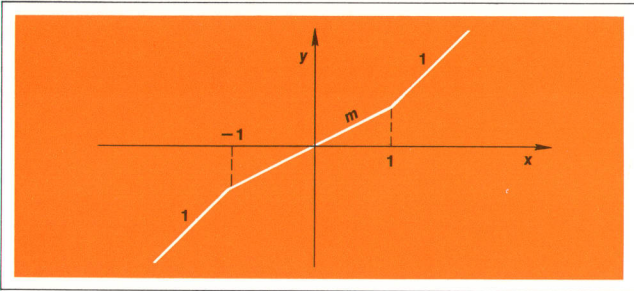

Fig. 8. Transfer characteristic of entire nonlinear stage.

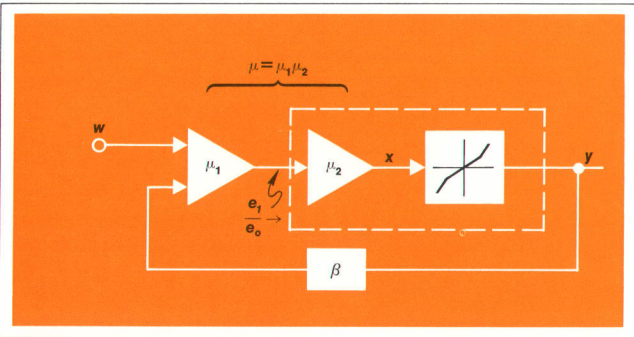

Fig. 9. Equivalent stage shown as part of an amplifier whose loop gain, above break point, is  $\mu\beta$ .

breakpoint is then given by:

$$y = \frac{m\mu}{1 - \mu\beta} w = sa \sin \phi, \phi < \phi_o \quad (33)$$

where

$$s = m \frac{1 - \mu\beta}{1 - m\mu\beta} \quad (34)$$

and

$$\phi_o = \sin^{-1} \frac{m}{sa}. \quad (35)$$

The quantity  $s$  will be recognized as the effective slope, as modified by the feedback. Beyond the breakpoint

$$(y - y_o) = \frac{\mu}{1 - \mu\beta} (w - w_o). \quad (36)$$

Using (32) and (33), this may be written

$$y = \alpha [\sin \phi - (1 - s) \sin \phi_o], \phi \geq \phi_o. \quad (37)$$

The fundamental component of the wave described by (33) and (37) is

$$a_1 = \frac{\int_0^{\pi/2} y \sin \phi \, d\phi}{\int_0^{\pi/2} \sin^2 \phi \, d\phi} = a \left[ 1 - (1 - s)K \right] \quad (38)$$

where 
$$K = \frac{2}{\pi} (\phi_o + \sin \phi_o \cos \phi_o). \quad (39)$$

The mean square difference between the actual wave and the fundamental is:

$$\begin{aligned} \overline{\delta a^2} &= \frac{\int_0^{\pi/2} (y - a_1)^2 \, d\phi}{\int_0^{\pi/2} d\phi} = \\ &= (1 - s)^2 a^2 \left\{ \frac{2\phi_o}{\pi} + \left( 1 - \frac{2\phi_o}{\pi} \right) \sin^2 \phi_o - \frac{K(K + 1)}{2} \right\}. \end{aligned} \quad (40)$$

Finally, the distortion is

$$d = \sqrt{\frac{\overline{\delta a^2}}{a_1^2}} = \sqrt{\frac{4\phi_o}{\pi} + 2 \left( 1 - \frac{2\phi_o}{\pi} \right) \sin^2 \phi_o - K(K + 1)} \left| \frac{1}{1 - s} - K \right|. \quad (41)$$

Expressions (38) through (41) are valid only if  $\phi_o \leq \frac{\pi}{2}$ , i.e., if  $a \geq \frac{m}{s} = \frac{1 - m\mu\beta}{1 - \mu\beta}$ . For  $a \leq \frac{m}{s}$ , there is no distortion although the gain is reduced. Of course, if  $m = 0$ , the output is zero for  $a \leq \frac{1}{1 - \mu\beta}$  and in a sense the distortion is large.

We note from (41) that  $d \rightarrow 0$  as  $\phi_o \rightarrow 0$  (large signals) and as  $\phi_o \rightarrow \frac{\pi}{2}$  (unless  $s = 0$ , in which case  $d \rightarrow \infty$ ).

There is thus some intermediate value of  $\phi_o$  at which the distortion is worst. However, it is not convenient to find this maximum by differentiating (41). Instead, the 9100A Calculator was programmed to plot  $d$  as a function of  $y$  for various values of  $m$  and  $\mu\beta$ .

Fig. 10 shows the distortion with no feedback and various values of  $m$ , while Figs. 11, 12 and 13 show the same values of  $m$ , but with 20 dB, 40 dB and 60 dB of feedback, respectively. The importance of having  $m > 0$  is evident, for with  $m = 0$  the distortion becomes infinite



as a  $\frac{E}{V_a} \rightarrow 1$ , regardless of the amount of feedback.

Fig. 14 shows the maximum distortion (expressed in dB) as a function of  $m$  for the same values of feedback. Note that for  $m = 0.6$  the maximum distortion is less than the fundamental by 20 dB + the feedback.

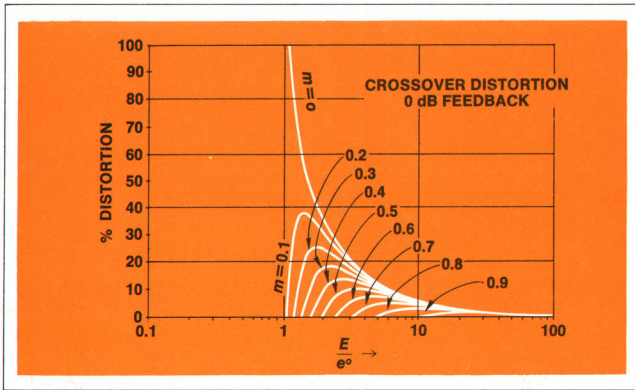

Fig. 10. Crossover distortion, 0 dB feedback.

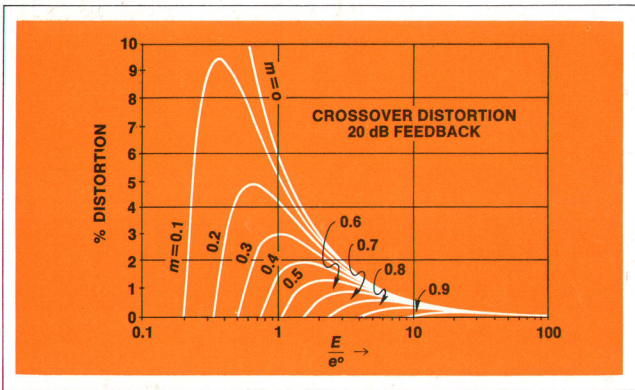

Fig. 11. Crossover distortion, 20 dB feedback.

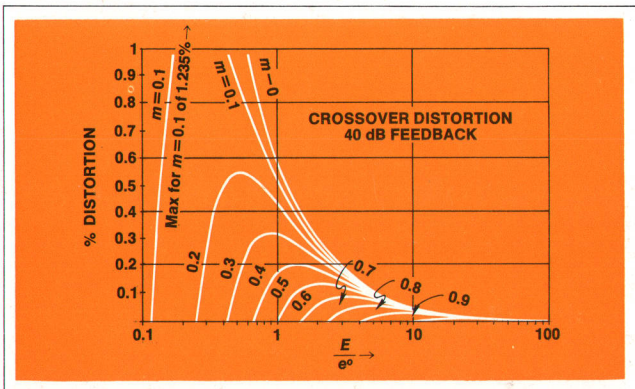

Fig. 12. Crossover distortion, 40 dB feedback.

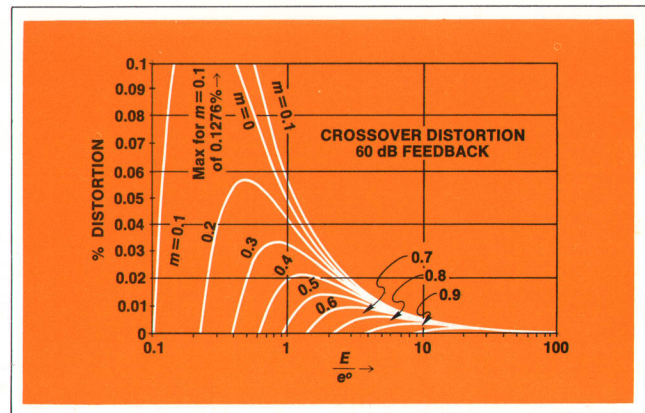

Fig. 13. Crossover distortion, 60 dB feedback.

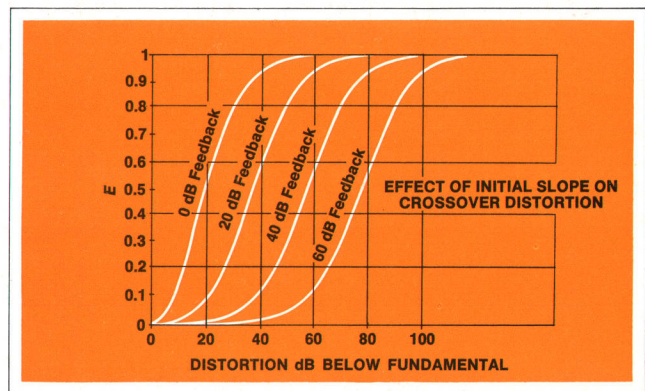

Fig. 14. Effect of initial slope on crossover distortion.

### Dr. Bernard M. Oliver



Barney Oliver is HP's vice president for research and development. His bachelor's in EE is from Stanford, his MS and PhD from Cal Tech. Before coming to HP he was a member of the technical staff at Bell Labs, making contributions to the development of automatic tracking radar, television, information theory, and efficient coding systems. He holds more than 50 patents, is a Fellow and a past president of

the IEEE, and a member of the National Academy of Engineering. He has also served as a lecturer in electrical engineering at Stanford.

At the company's headquarters in Palo Alto, Barney directs the activities of HP Laboratories, a centralized, multi-disciplinary facility which pursues advanced design projects on behalf of all the firm's divisions.